



# Upflow/Horizontal Condensing, Gas-Fired Furnace

---

## **XB 90**

TUC1B040A9241A, TUC1B060A9361A  
TUC1B080A9421A, TUC1C100A9481A  
TUC1D100A9601A, TUC1D120A9601A  
Single-Stage Fan Assisted  
Combustion System

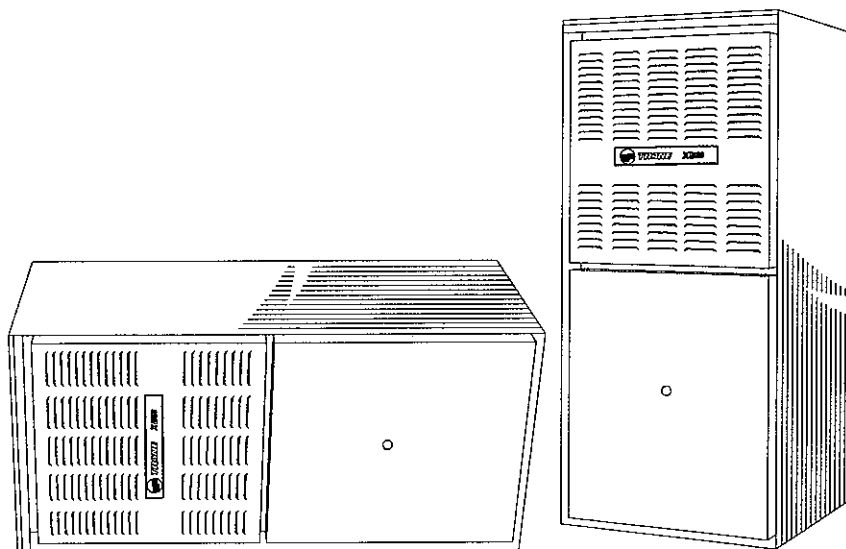

---

PUB. NO. 22-1669-08



# General Features

---

## **NATURAL GAS MODELS**

Central Heating furnace designs are certified by the American Gas Association for both natural and L.P. gas. Limit setting and rating data were established and approved under standard rating conditions using American National Standards Institute standards.

## **SAFE OPERATION**

The Integrated System Control has solid state devices, which continuously monitor for presence of flame, when the system is in the heating mode of operation. Dual solenoid combination gas valve and regulator provide extra safety.

## **QUICK HEATING**

Durable, cycle tested, heavy gauge **aluminized steel heat exchanger** quickly transfers heat to provide warm conditioned air to the structure. **Low energy power vent blower**, to increase efficiency and provide a positive discharge of gas fumes to the outside.

## **BURNERS**

Multipoint Inshot burners will give years of quiet and efficient service. All models can be converted to **L.P. gas** without changing burners.

## **INTEGRATED SYSTEM CONTROL**

Exclusively designed operational program provides total control of furnace limit sensors, blowers, gas valve, flame control and includes self diagnostics for ease of service. Also contains connection points for E.A.C./humidifier.

## **AIR DELIVERY**

The variable speed, direct drive blower motor, has sufficient airflow for most heating and cooling requirements, will switch from heating to cooling speeds on demand from room thermostat. The blower door safety switch will prevent or terminate furnace operation when the blower door is removed.

## **STYLING**

**Heavy gauge steel and "wrap-around" cabinet construction** is used in the cabinet with baked-on enamel finish for strength and beauty. The heat exchanger section of the cabinet is completely lined with foil faced fiberglass insulation. This results in quiet and efficient operation due to the excellent acoustical and insulating qualities of fiberglass. Built-in bottom pan and alternate bottom, left or right side return air connection provision.

## **FEATURES AND**

### **GENERAL OPERATION**

The XB 90 High Efficiency Gas Furnaces employ a Hot Surface Ignition system, which eliminates the waste of a constant burning pilot. The integrated system control lights the main burners upon a demand for heat from the room thermostat. Complete front service access.

- a. Low energy power venter
- b. Vent proving pressure switch.



# Contents

---

<b>Feature Summary</b>	<b>2</b>
<b>Features and Benefits</b>	<b>4</b>
Standard Equipment	
Optional Equipment	
<b>General Data</b>	<b>5</b>
TUC1B040A9241A	
TUC1B060A9361A	
TUC1B080A9421A	
TUC1C100A9481A	
TUC1D100A9601A	
TUCAD120A9601A	
<b>Performance Data</b>	<b>7</b>
<b>Electrical Data</b>	<b>8</b>
<b>Field Wiring</b>	<b>10</b>
<b>Dimensions</b>	<b>11</b>



# Features and Benefits

## **XB 90 STANDARD EQUIPMENT**

- Power supply 115/1/60
- Upflow convertible to horizontal left
- **Type 29-4C™** stainless steel secondary heat exchanger
- Direct drive, 4-speed motor
- Silicon Carbide hot surface igniter with adaptive heat up
- Accessory hook-up capability-Hum & EAC
- Quiet induced draft blower
- Blower door safety switch
- Dual solenoid combination gas valve & regulator
- PVC venting - 1 Pipe
- Left/right gas connection
- Integrated solid state control with self-diagnostics
- Selectable cooling fan off delay eliminates need for BAY24X045 time delay relay
- 24 volt fuse
- Manual reset burner box limit
- **Optional extended warranties**

## **XB 90 OPTIONAL EQUIPMENT**

Thermostat, Mechanical Heating Only Without Fan Switch .....	BAYSTAT388 [ ]
Thermostat, Electronic Programmable 1-Stage Heating/1-Stage Cooling .....	TAYSTAT300C [ ]
Propane Conversion Kit .....	BAYLPKT210A [ ]
Electronic Air Filter, "Perfect Fit" Super Efficiency (17-1/2" Wide Gas Furnace) .....	TFE175A9FR0 [ ]
Electronic Air Filter, "Perfect Fit" Super Efficiency (21" Wide Gas Furnace) .....	TFE210A9FR0 [ ]
Electronic Air Filter, "Perfect Fit" Super Efficiency (24-1/2" Wide Gas Furnace) .....	TFE245A9FR0 [ ]
Electronic Air Filter, "Perfect Fit" High Efficiency (17-1/2" Wide Gas Furnace) .....	TFM175A9FR0 [ ]
Electronic Air Filter, "Perfect Fit" High Efficiency (21" Wide Gas Furnace) .....	TFM210A9FR0 [ ]
Electronic Air Filter, "Perfect Fit" High Efficiency (24-1/2" Wide Gas Furnace) .....	TFM245A9FR0 [ ]
Electronic Air Filter, "Perfect Fit" Standard Efficiency (17-1/2" Wide Gas Furnace) .....	TFP175A9FR0 [ ]
Electronic Air Filter, "Perfect Fit" Standard Efficiency (21" Wide Gas Furnace) .....	TFP210A9FR0 [ ]
Electronic Air Filter, "Perfect Fit" Standard Efficiency (24-1/2" Wide Gas Furnace) .....	TFP245A9FR0 [ ]
Coil Enclosure (17-1/2" Wide Cabinets) .....	BAYCLE17A1722A [ ]
Coil Enclosure (21" Wide Cabinets) .....	BAYCLE21A2130A [ ]
Coil Enclosure (24-1/2" Wide Cabinets) .....	BAYCLE24A2430A [ ]
Side Filter Rack .....	BAYFLTR200 [ ]
High Altitude Switch .....	BAYHALT225 [ ]
High Altitude Switch .....	BAYHALT226 [ ]
High Altitude Switch .....	BAYHALT228 [ ]
High Altitude Switch .....	BAYHALT240 [ ]
Filter Kit Horizontal coversion TUC01B40,060,080C .....	BAYFLTR203 [ ]
Filter Kit Horizontal coversion TUC1C100X948B .....	BAYFLTR204 [ ]
Filter Kit Horizontal coversion TUC1D100C960, TUC1D120C .....	BAYFLTR205 [ ]
Twinning Kit .....	BAYTWIN400A [ ]
Wall Mount Flange-3" .....	BAY96X147 [ ]
Wall Mount Flange-2" .....	BAY96X148 [ ]
Horizontal Vent Cap (Noryl) .....	BAY96X146 [ ]



# General Data

## PRODUCT SPECIFICATIONS ①

MODEL	TUC1B040A9241A	TUC1B060A9361A	TUC1B080A9421A
<b>TYPE</b>	Upflow / Horizontal	Upflow / Horizontal	Upflow / Horizontal
<b>RATINGS ②</b>			
Input BTUH	40,000	60,000	80,000
Capacity BTUH (ICS) ③	37,000	56,000	74,000
AFUE	92.0	92.0	92.0
Temp. rise (Min.-Max.) °F.	30 - 60	30 - 60	35 - 65
<b>BLOWER DRIVE</b>	DIRECT	DIRECT	DIRECT
Diameter - Width (In.)	9 x 7	10 x 7	10 x 8
No. Used	1	1	1
Speeds (No.)	4	4	4
CFM vs. in. w.g.	See Fan Performance Table	See Fan Performance Table	See Fan Performance Table
Motor HP	1/5	1/3	1/3
R.P.M.	1075	1075	1075
Volts / Ph / Hz	115/1/60	115/1/60	115/1/60
<b>COMBUSTION FAN - Type</b>	Centrifugal	Centrifugal	Centrifugal
Drive - No. Speeds	Direct - 1	Direct - 1	Direct - 1
Motor HP - RPM	1/55 - 3000	1/55 - 3000	1/25 - 3200
Volts / Ph / Hz	115/1/60	115/1/60	115/1/60
FLA	1.0	1.0	1.35
<b>FILTER — Furnished?</b>	No	No	No
Type Recommended	High Velocity	High Velocity	High Velocity
Hi Vel. (No.-Size-Thk.)	1 - 17x25 - 1in.	1 - 17x25 - 1in.	1 - 17x25 - 1in.
<b>VENT — Size (in.)</b>	2 Round	2 Round	2 Round
<b>HEAT EXCHANGER</b>			
Type-Fired	Aluminized Steel - Type I	Aluminized Steel - Type I	Aluminized Steel - Type I
-Unfired			
Gauge (Fired)	20	20	20
<b>ORIFICES — Main</b>			
Nat. Gas Qty. — Drill Size	2 — 45	3 — 45	4 — 45
L.P. Gas Qty. — Drill Size	2 — 56	3 — 56	4 — 56
<b>GAS VALVE</b>	Redundant - Single Stage	Redundant - Single Stage	Redundant - Single Stage
<b>PILOT SAFETY DEVICE</b>			
Type	Hot Surface Ignition	Hot Surface Ignition	Hot Surface Ignition
<b>BURNERS — Type</b>	Multiport Inshot	Multiport Inshot	Multiport Inshot
Number	2	3	4
<b>POWER CONN. — V / Ph / Hz ④</b>	115/1/60	115/1/60	115/1/60
Ampacity (In Amps)	4.7	8.3	9.4
Max Overcurrent Protection (Amps)	15	15	15
<b>PIPE CONN. SIZE (IN.)</b>	1/2	1/2	1/2
<b>DIMENSIONS</b>			
Crated (In.)	H x W x D 41-3/4 x 19-1/2 x 30-1/2	H x W x D 41-3/4 x 19-1/2 x 30-1/2	H x W x D 41-3/4 x 19-1/2 x 30-1/2
<b>WEIGHT</b>			
Shipping (Lbs.) / Net (Lbs)	139 / 129	150 / 140	158 / 148

① Central Furnace heating designs are certified by AGA and CSA.

② For U.S. applications, above input ratings (BTUH) are up to 2,000 feet, derate 4% per 1,000 feet for elevations above 2,000 feet above sea level. For Canadian applications, above input ratings (BTUH) are up to 4,500 feet, derate 4% per 1,000 feet for elevations above 4,500 feet above sea level.

③ Based on U.S. government standard tests.

④ The above wiring specifications are in accordance with National Electrical Code; however, installations must comply with local codes.



# General Data

## PRODUCT SPECIFICATIONS ①

MODEL	TUC1C100A9481A	TUC1D100A9601A	TUC1D120A9601A
TYPE	Upflow / Horizontal	Upflow / Horizontal	Upflow / Horizontal
<b>RATINGS ②</b>			
Input BTUH	100,000	100,000	120,000
Capacity BTUH (ICS) ③	94,000	93,000	113,000
AFUE	92.0	92.0	92.0
Temp. rise (Min.-Max.) °F.	35 - 65	35 - 65	40 - 70
<b>BLOWER DRIVE</b>	DIRECT	DIRECT	DIRECT
Diameter - Width (In.)	10 x 10	11 x 10	11 x 10
No. Used	1	1	1
Speeds (No.)	4	4	4
CFM vs. in. w.g.	See Fan Performance Table	See Fan Performance Table	See Fan Performance Table
Motor HP	1/2	3/4	3/4
R.P.M.	1075	1100	1100
Volts / Ph / Hz	115/1/60	115/1/60	115/1/60
<b>COMBUSTION FAN - Type</b>	Centrifugal	Centrifugal	Centrifugal
Drive - No. Speeds	Direct - 1	Direct - 1	Direct - 1
Motor HP - RPM	1/20 - 3450	1/20 - 3450	1/20 - 3450
Volts / Ph / Hz	115/1/60	115/1/60	115/1/60
FLA	0.71	0.71	0.71
<b>FILTER — Furnished?</b>	No	No	No
Type Recommended	High Velocity	High Velocity	High Velocity
Hi Vel. (No.-Size-Thk.)	1 - 20x25 - 1in.	1 - 24x25 - 1in.	1 - 24x25 - 1in.
<b>VENT — Size (in.)</b>	2 Round	2 Round	3 Round
<b>HEAT EXCHANGER</b>			
Type-Fired	Aluminized Steel - Type I	Aluminized Steel - Type I	Aluminized Steel - Type I
-Unfired			
Gauge (Fired)	20	20	20
<b>ORIFICES — Main</b>			
Nat. Gas Qty. — Drill Size	5 — 45	5 — 45	6 — 45
L.P. Gas Qty. — Drill Size	5 — 56	5 — 56	6 — 56
<b>GAS VALVE</b>	Redundant - Single Stage	Redundant - Single Stage	Redundant - Single Stage
<b>PILOT SAFETY DEVICE</b>			
Type	Hot Surface Ignition	Hot Surface Ignition	Hot Surface Ignition
<b>BURNERS — Type</b>	Multiport Inshot	Multiport Inshot	Multiport Inshot
Number	5	5	6
<b>POWER CONN. — V / Ph / Hz ④</b>	115/1/60	115/1/60	115/1/60
Ampacity (In Amps)	12.5	12.9	12.9
Max Overcurrent Protection (Amps)	15	15	15
<b>PIPE CONN. SIZE (IN.)</b>	1/2	1/2	1/2
<b>DIMENSIONS</b>	H x W x D	H x W x D,	H x W x D
Crated (In.)	41-3/4 x 23 x 30-1/2	41-3/4 x 26-1/2 x 30-1/2	41-3/4 x 26-1/2 x 30-1/2
<b>WEIGHT</b>			
Shipping (Lbs.) / Net (Lbs)	171 / 160	197 / 185	205 / 193

① Central Furnace heating designs are certified by AGA and CSA.

② For U.S. applications, above input ratings (BTUH) are up to 2,000 feet, derate 4% per 1,000 feet for elevations above 2,000 feet above sea level. For Canadian applications, above input ratings (BTUH) are up to 4,500 feet, derate 4% per 1,000 feet for elevations above 4,500 feet above sea level.

③ Based on U.S. government standard tests.

④ The above wiring specifications are in accordance with National Electrical Code; however, installations must comply with local codes.



# Performance Data

FURNACE AIRFLOW (CFM) VS. EXTERNAL STATIC PRESSURE (INS. w.g.)										
MODEL	SPEED TAP	0.10	0.20	0.30	0.40	0.50	0.60	0.70	0.80	0.90
TUC1B040A9241A	4 - HIGH - Black	1043	992	930	885	812	740	647	518	157
	3 - MED.-HIGH - Blue	940	895	841	791	726	650	559	420	90
	2 - MED.-LOW - Yellow	837	798	752	705	649	560	438	305	79
	1 - LOW - Red	729	694	657	600	545	478	376	220	78
TUC1B060A9361A	4 - HIGH - Black	1394	1359	1314	1260	1196	1122	1038	945	853
	3 - MED.-HIGH - Blue	1250	1232	1202	1160	1106	1040	962	873	771
	2 - MED.-LOW - Yellow	1102	1092	1069	1034	986	925	852	766	668
	1 - LOW - Red	957	944	922	891	853	806	750	686	614
TUC1B080A9421A	4 - HIGH - Black	1748	1683	1615	1544	1470	1393	1314	1232	1147
	3 - MED.-HIGH - Blue	1375	1367	1347	1314	1268	1210	1139	1056	960
	2 - MED.-LOW - Yellow	1178	1167	1147	1119	1082	1036	982	919	847
	1 - LOW - Red	859	863	856	839	811	772	723	663	592
TUC1C100A9481A	4 - HIGH - Black	2054	1980	1906	1826	1746	1649	1551	1428	1305
	3 - MED.-HIGH - Blue	1932	1875	1818	1746	1673	1577	1481	1371	1260
	2 - MED.-LOW - Yellow	1762	1720	1677	1615	1552	1463	1373	1266	1158
	1 - LOW - Red	1558	1546	1533	1477	1421	1350	1278	1175	1071
TUC1D100A9601A	4 - HIGH - Black	2411	2358	2304	2235	2165	2083	2001	1915	1828
	3 - MED.-HIGH - Blue	2108	2083	2058	2007	1956	1893	1829	1754	1679
	2 - MED.-LOW - Yellow	1772	1759	1745	1723	1700	1657	1613	1544	1475
	1 - LOW - Red	1480	1477	1474	1458	1441	1414	1386	1327	1268
TUC1D120A9601A	4 - HIGH - Black	2454	2406	2358	2310	2261	2184	2106	2017	1928
	3 - MED.-HIGH - Blue	2105	2092	2078	2045	2012	1950	1887	1826	1765
	2 - MED.-LOW - Yellow	1747	1742	1736	1720	1703	1677	1651	1593	1535
	1 - LOW - Red	1445	1447	149	1440	1430	1400	1369	1325	1280

CFM VS. TEMPERATURE RISE																	
MODEL	Cubic Feet Per Minute (CFM)																
	600	700	800	900	1000	1100	1200	1300	1400	1500	1600	1700	1800	1900	2000	2100	2200
TUC1B040A9241A	56	48	42	37	33												
TUC1B060A9361A				56	50	45	42	39	36								
TUC1B080A9421A						61	56	51	48	44	42						
TUC1C100A9481A								64	60	56	52	49	46	44	42		
TUC1D100A9601A								64	60	56	52	49	46	44	42	40	38
TUC1D120A9601A											63	59	56	53	50	48	46



# Electrical Data

## SCHEMATIC DIAGRAMS FOR GAS FURNACES

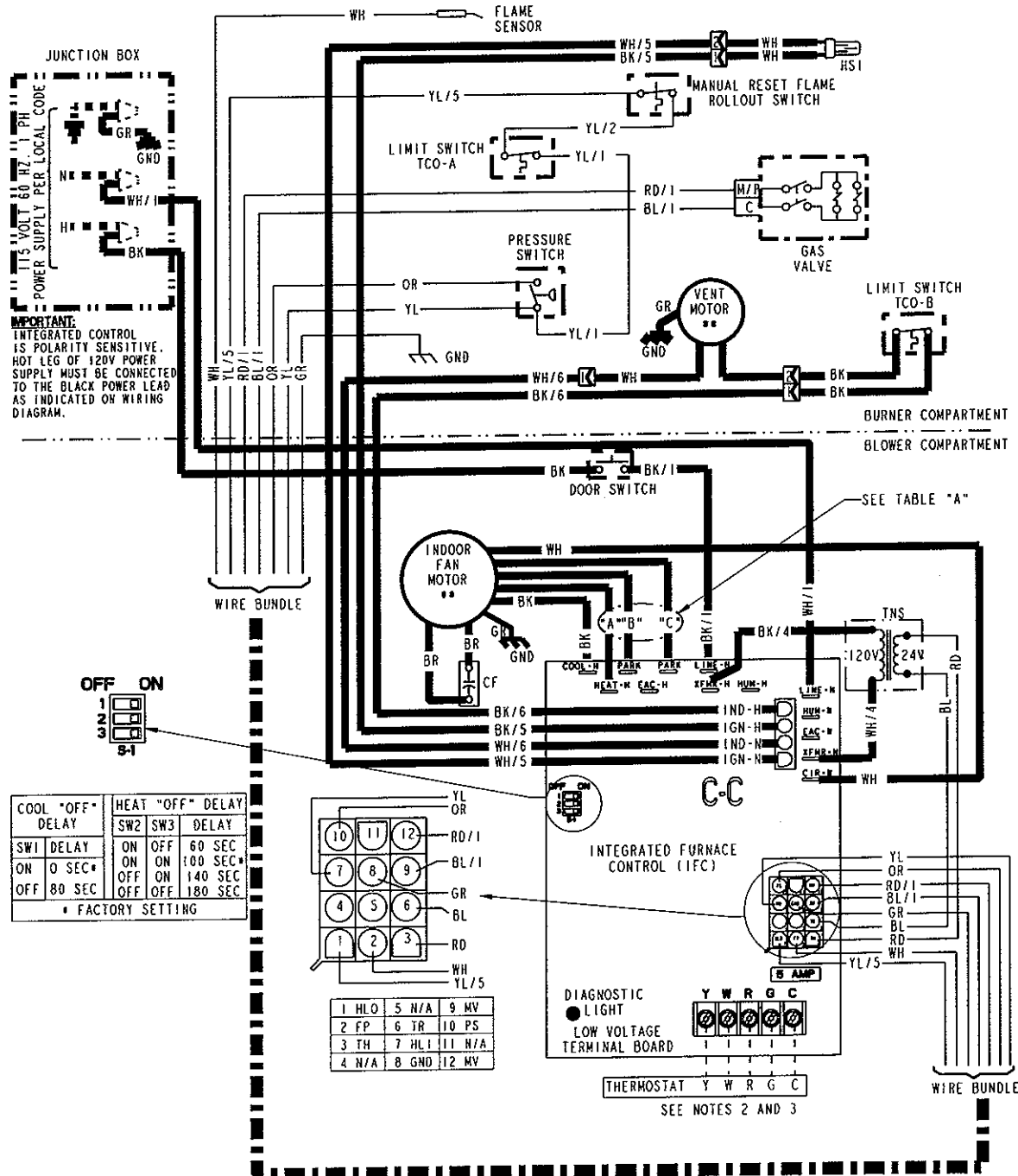





# Electrical Data

## SCHEMATIC DIAGRAMS FOR GAS FURNACES

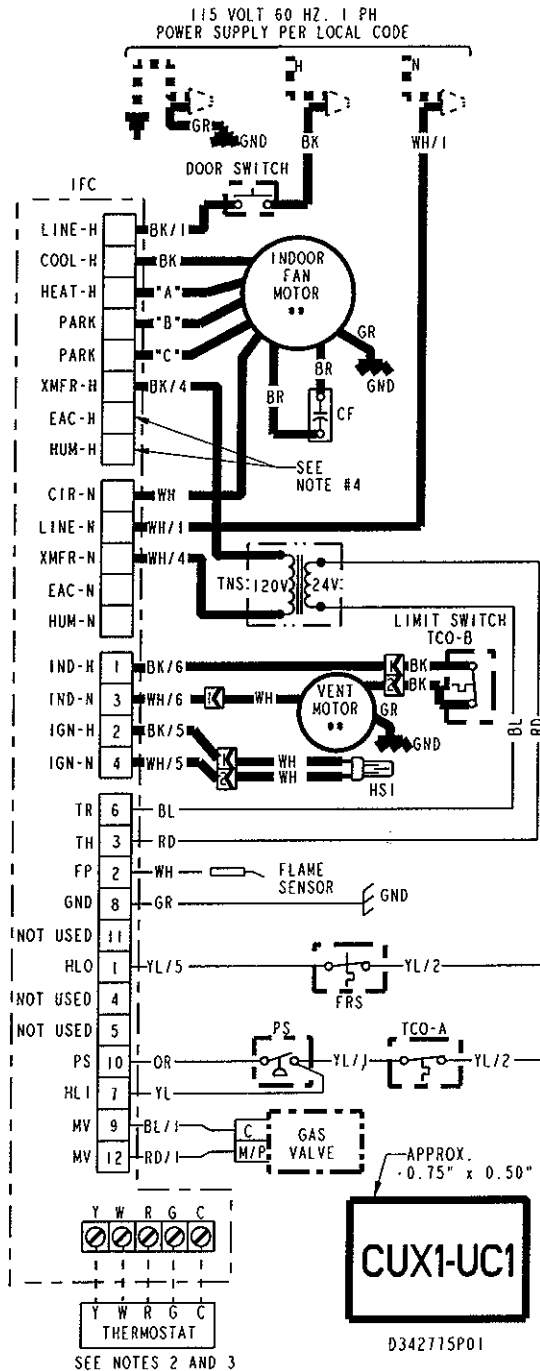

MODEL	SPEED TAPS FOR I. D. FAN MOTOR		
	HEAT "A"	PARK "B"	PARK "C"
CUX1B040A9241A* #UC1B040A9241A*	YL	RD	BL
CUX1B060A9361A* #UC1B060A9361A*	BL	RD	YL
CUX1B080A9421A* #UC1B080A9421A*	BL	RD	YL
CUX1C100A9481A* #UC1C100A9481A*	BL	RD	YL
CUX1D100A9601A* #UC1D100A9601A*	YL	RD	BL
CUX1D120A9601A* #UC1D120A9601A*	BL	RD	YL

RD = LOW      BL = MED. HIGH  
YL = MED. LOW      BK = HIGH  
# - MAY BE "T" or "A"  
\* - MAY BE A THROUGH Z

**WARNING**

HAZARDOUS VOLTAGE:  
DISCONNECT ALL ELECTRICAL POWER INCLUDING REMOTE DISCONNECTS BEFORE SERVICING.  
FAILURE TO DISCONNECT POWER BEFORE SERVICING CAN CAUSE SEVERE PERSONAL INJURY OR DEATH.

**CAUTION**

USE COPPER CONDUCTORS ONLY!  
UNIT TERMINALS ARE NOT DESIGNED TO ACCEPT OTHER TYPES OF CONDUCTORS.  
FAILURE TO DO SO MAY CAUSE DAMAGE TO THE EQUIPMENT.

**INTEGRATED FURNACE CONTROL**  
REPLACE WITH PART CNT02891 OR CNT 02183 OR EQUIVALENT  
INPUT: 25 VAC, 60 HZ.  
XFMR SEC. CURRENT: 450 MA.  
MV OUTPUT: 1.5 A @ 24 VAC  
IND OUTPUT: 2.2 FLA, 3.5 LRA @ 120 VAC  
CIRC. BLOWER OUTPUT: 14.5 FLA, 26 LRA @ 120 VAC  
HUMIDIFIER & AIR CLEANER  
MAX. LOAD: 1.0 A @ 120 VAC  
IGNITER OUTPUT: 6.0 A @ 120 VAC

**DIAGNOSTIC CODES**

- FLASHING SLOW: NORMAL - NO CALL FOR HEAT
- FLASHING FAST: NORMAL - CALL FOR HEAT
- CONTINUOUS ON: REPLACE IFC
- CONTINUOUS OFF: CHECK POWER
- 2 FLASHES: EXTERNAL LOCKOUT (RETRIES OR RECYCLES EXCEEDED)
- 3 FLASHES: PRESSURE SWITCH ERROR
- 4 FLASHES: OPEN LIMIT DEVICE
- 5 FLASHES: FLAME SENSED WHEN NO FLAME SHOULD BE PRESENT
- 6 FLASHES: 115 VAC POWER REVERSED POLARITY OR POOR GROUNDING
- 7 FLASHES: GAS VALVE CIRCUIT ERROR
- 8 FLASHES: LOW FLAME SENSE SIGNAL

TCO THERMAL CUT OUT

PS PRESSURE SWITCH

FRS FLAME ROLLOUT SWITCH

FP FLAME SENSOR

CHASSIS GROUND

HSI HOT SURFACE IGNITER

DOOR SWITCH

CF CAPACITOR

COIL

WIRE COLOR

BK BLACK      GR GREEN  
WH WHITE      BR BROWN  
YL YELLOW      RD RED  
OR ORANGE      BL BLUE

BK/1 WIRE COLOR NUMBER 10 (IF ANY)

L LINE      TH 24 VAC (HOT)  
N NEUTRAL      TR 24 VAC (COMMON)  
GND GROUND      MV MAIN GAS VALVE  
B/C COMMON      TNS TRANSFORMER  
HLO HIGH LIMIT OUTPUT  
HLI HIGH LIMIT INPUT

**NOTES:**

- IF ANY OF THE ORIGINAL WIRING AS SUPPLIED WITH THIS FURNACE MUST BE REPLACED, IT MUST BE WITH WIRE HAVING A TEMPERATURE RATING OF AT LEAST 105 C.
- THERMOSTAT HEAT ANTICIPATOR SETTING: .38 AMPS
- FOR PROPER OPERATION OF COOLING SPEED, "Y" TERMINAL MUST BE CONNECTED TO THE ROOM THERMOSTAT.
- THESE TERMINALS PROVIDE 120V POWER CONNECTIONS FOR ELECTRONIC AIR CLEANER (EAC) AND HUMIDIFIER (HUM). MAX. LOAD: 1.0 AMPS EACH.



# Field Wiring

## FIELD WIRING DIAGRAM FOR HEATING ONLY

FIELD WIRING DIAGRAM  
FOR SINGLE STAGE HEATING

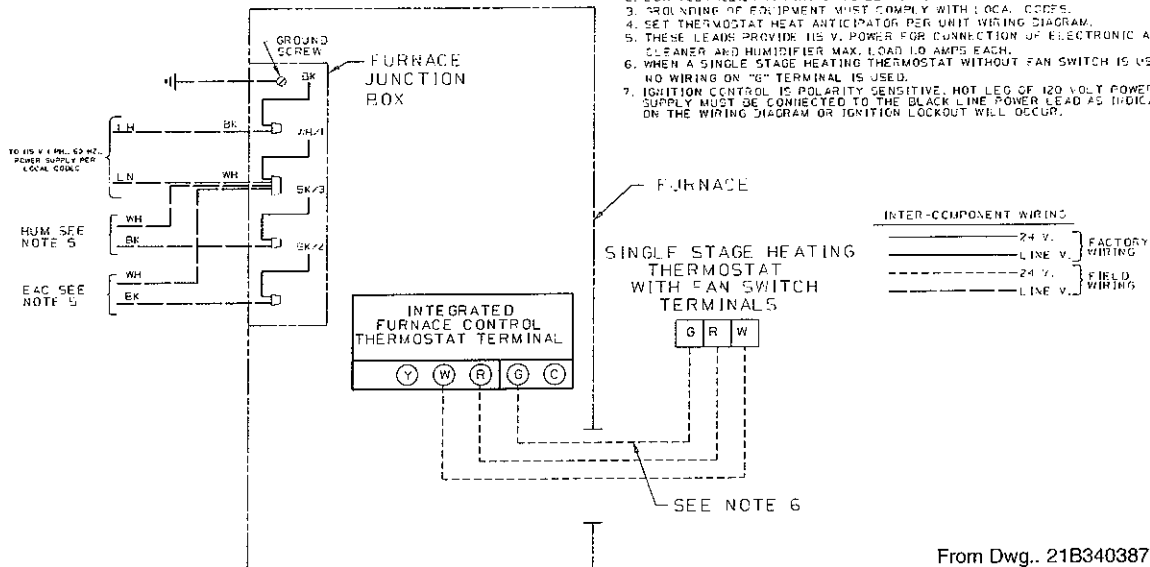

From Dwg.. 21B340387 Rev. 1

## FIELD WIRING DIAGRAM FOR SINGLE STAGE HEATING/COOLING (OUTDOOR SECTION WITHOUT TRANSFORMER)

FIELD WIRING DIAGRAM  
FOR SINGLE STAGE HEATING/COOLING  
(OUTDOOR SECTION WITHOUT TRANSFORMER)

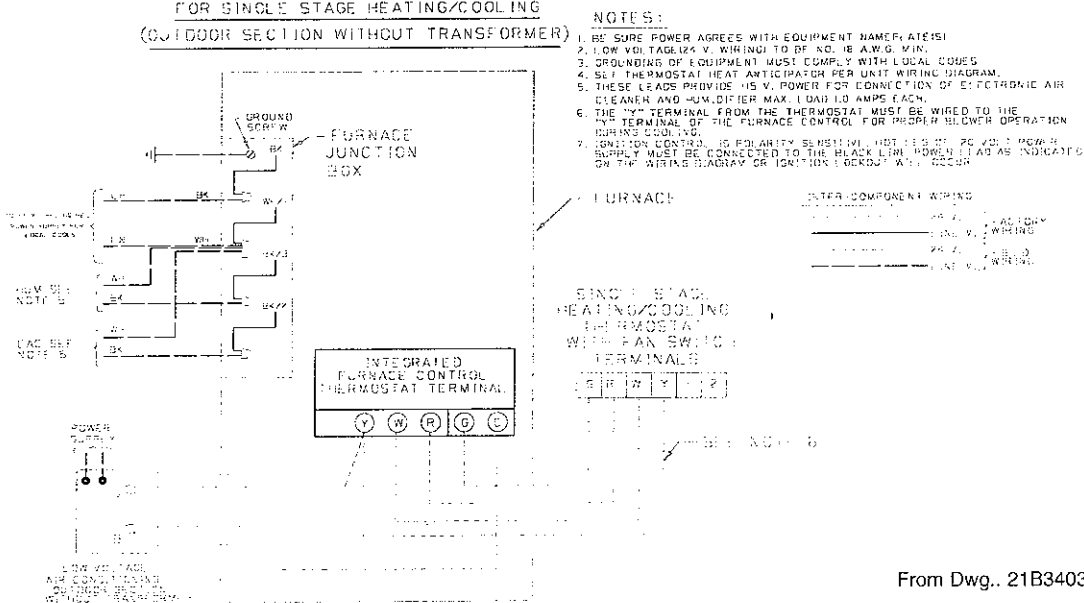

From Dwg.. 21B340388 Rev. 1

# Dimensions

## TUC1 OUTLINE DRAWING (ALL DIMENSIONS ARE IN INCHES)

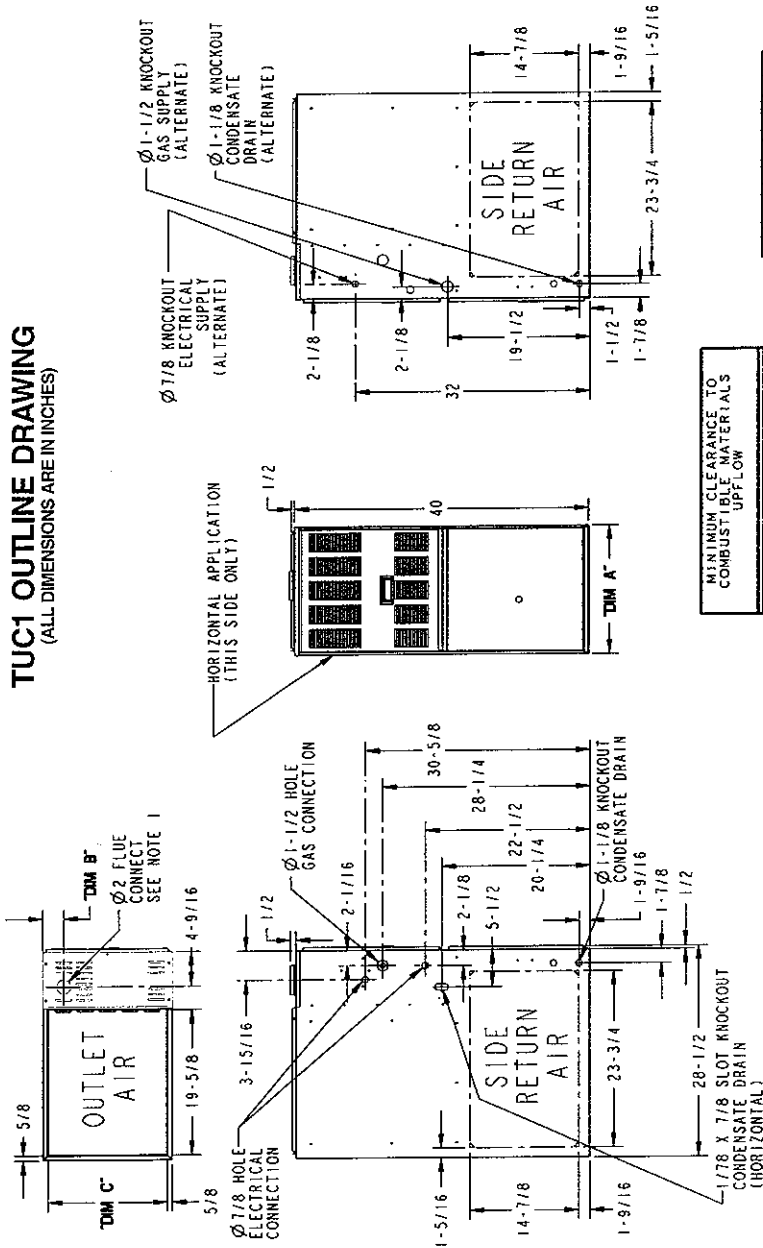

MINIMUM CLEARANCE TO COMBUSTIBLE MATERIALS UPFLOW	
SIDES	0"
REAR	0"
FRONT	3"
TOP	1"
FLUE	0"
HORIZONTAL (FLUE DISCHARGE LEFT SIDE ONLY)	
ALCOVE SIDES	1"
LEFT	0"
RIGHT	6"
REAR	18"
FRONT	18"
TOP	18"
FLUE	0"
CLOSED	
SIDES	1"
LEFT	1"
REAR	3"
FRONT	3"
TOP	1"
FLUE	0"

**NOTES:**  
1. \*UC100C, UC100A, \*UC120C, & UC120A REQUIRE 2-1/2" OR 3" DIAMETER VENT PIPE.

MODEL (SEE NOTE)	DIM "A"	DIM "B"	DIM "C"	DIM "C"
*UC1B040A9241A**	17-1/2"	2-1/4"	16-1/4"	16"
*UC1B060A9361A**	21"	2-1/2"	19-3/4"	16-1/2"
*UC1B080A9421A**	24-1/2"	2-15/16"	23-1/4"	23"

\* - Prefix letter may be "A" or "T"  
\*\* - Suffix letters may be "A" through "Z"



**TRANE**<sup>®</sup>

Trane  
6200 Troup Highway  
Tyler, TX 75707

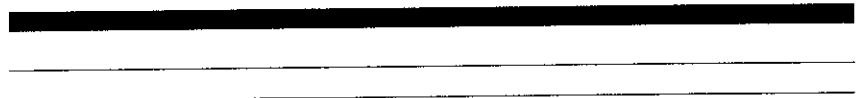

Since Trane has a policy of continuous product and product data improvement, it reserves the right to change design and specifications without notice.